

Chain Edge Belt (to be used with a mesh datasheet)

Product Description

Chain edged mesh with a connecting rod through the mesh

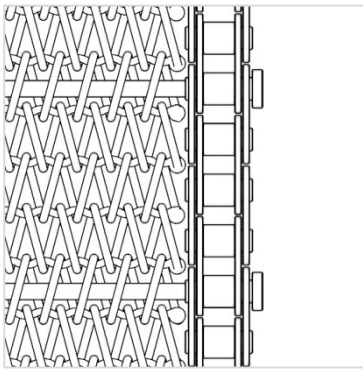

Chain Types

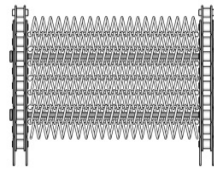

Transmission

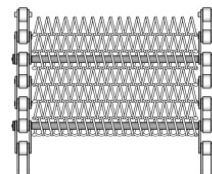

Conveyor

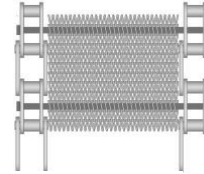

Freezer Type

Selvedge Options

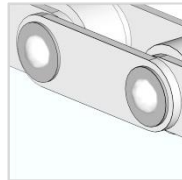

WWS
 (Welded Washer Selvedge)
 Rods go through the chain and then retained by a washer welded in place.

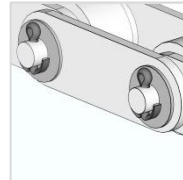

CPS
 (Cotter Pin Selvedge)

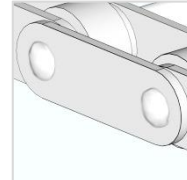

WRS
 (Welded Rod Selvedge)
 Ends of the rod are welded directly to outside of the chain

Information Required To Quote (used in conjunction with mesh datasheet)

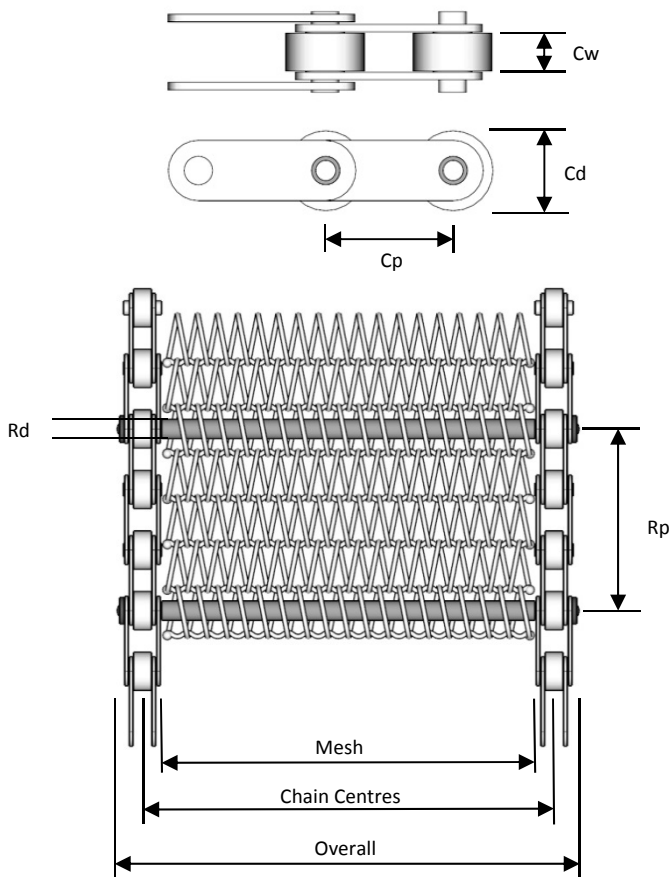

Chain	
‘Cp’ - Chain Pitch	
‘Cd’ - Roller Diameter	
‘Cw’ - Roller Width	
Chain Material	
Rods	
‘Rd’ - Rod Diameter	
‘Rp’ - Rod Pitch	
Rod Material	
Width	
Mesh	
Chain Centres	
Overall	
Length	
Selvedge Type	